

# TAKSTAR® 得胜



## 无线麦克风 Wireless Microphone

使用手册 | User Manual

# UC-2R/UC-4R 无线麦克风

## ■ 前言

尊敬的用户：

感谢您选购得胜UC-2R/UC-4R无线麦克风，为了您能够更好的了解使用本产品，建议您在使用前仔细阅读本说明书。

若存在有疑问或者您有宝贵的建议，可通过拨打得胜官方服务热线400 6828 333或微信扫描二维码关注得胜官方公众号与我们联系。



## ■ 产品特性

- 整个系统硬件电路由微电脑CPU控制，可以进行选频、显示、频率数据处理及自动频道追锁等功能；
- 采用双液晶LCD显示，所有操作均可在液晶屏显示，方便用户了解系统工作状态及对系统进行设置；
- 所有发射机的电池电量可实时显示在各自的液晶显示屏上，并在电池低电量时发出警告提示；
- 系统应用多种抗干扰技术，出厂时系统已预置多个互不干扰的频点，方便用户多系统同时使用；
- 音频输出设有XLR平衡式插座输出和6.35非平衡式插座输出两种方式，方便用户连接到不同的外部设备上；
- 使用1U金属机箱，铝合金面板，坚固美观及隔离谐波辐射的专业品质。

## ■ 适用范围

适用卡拉OK演唱、会议、节目主持、演讲、户外活动等场合

## ■ 技术参数

### 接收机(UC-2R/UC-4R)

- 杂散抑制：N50dB
- 音频输出电平：
  - 平衡输出（XLR output jack）：1200mV/600Ω
  - UC-2R
  - 非平衡输出（6.35 output jack）：900mV/3KΩ
  - UC-4R
  - 非平衡输出（6.35 output jack）：400mV/3KΩ
- 镜象抑制：N50dB
- 灵敏度：>25dBu（SIND=35dB）
- 工作电压：DC 12V 工作电流：1A
- 机箱尺寸：480(宽) X 190(深) X 45(高) mm

# UC-2R/UC-4R 无线麦克风

---

## 发射器(UC-TH1/UC-TH2/UC-TL/UC-TP/UC-TD)

- RF功率输出：最大30mW（国标电源）
- 振荡模式：PLL（数字频率合成器）
- 发射频率稳定度：<30ppm
- 动态范围：≥50dB（A）
- 频率响应：80Hz-18KHz
- 最大输入声压：130dBSPL
- 手持式麦克风拾音头：动圈式
- 腰挂式/会议麦克风拾音头：电容式
- 电源：2节AA型碱性电池（预期使用时间约为8小时）

## 发射器(UC-LD/UC-LH1/UC-LH2)

- RF功率输出：最大13mW
- 振荡模式：PLL（数字频率合成器）
- 发射频率稳定度：<30ppm
- 动态范围：≥50dB（A）
- 频率响应：80Hz-18KHz
- 杂散抑制：-60dB
- 手持式麦克风拾音头：动圈式
- 会议麦克风拾音头：电容式
- 电池：1节 18650 3.7V/1200mA 约8小时
- 充电规格：DC 5V = 1A

## 综合特性

- 频率范围：580-630MHz
  - 频带宽度：60MHz
  - 调制方式：FM调频
  - 最大频偏：±45KHz
  - 频率响应：80Hz-18KHz
  - 信噪比（S/N）：>50dB
  - 失真度：1kHz<0.5%
  - 工作温度：TOP ~ 55°C
  - 工作距离：100米（理想环境下）
  - 消耗功率：8W
  - 静态功率：3W
- 注：以上数据由得胜实验室测试得到。

# UC-2R/UC-4R 无线麦克风

---

## ■ 产品配置

### UC-2R

接收机	1台
音频信号连接线	1条
电源适配器	1个
天线	2支
使用说明书	1份

### UC-TP (选配)

腰包式发射机	1个
领夹麦克风	1个
头戴麦克风	1个
1.5V AA 电池	2节

### UC-TH1 (选配)

会议底座	1个
鹅颈麦克风	1个
1.5V AA 电池	2节

### UC-LD (选配)

手持式发射机	1个
3.7V 18650	1节
防滑圈	1个
充电线	1条

### UC-LH1 (选配)

会议底座	1个
鹅颈麦克风	1个
3.7V 18650	1节
充电线	1条

### UC-4R

接收机	1台
音频信号连接线	1条
电源适配器	1个
天线	4支
使用说明书	1份

### UC-TD (选配)

手持式发射机	1个
1.5V AA 电池	2节

### UC-TH2 (选配)

会议底座	1个
短杆 (方形) 麦克风	1个
1.5V AA 电池	2节

### UC-LH2 (选配)

会议底座	1个
短杆 (方形) 麦克风	1个
3.7V 18650	1节
充电线	1条

# UC-2R/UC-4R 无线麦克风

## ■ 功能示意

### 接收机（一拖二）

#### 前面板

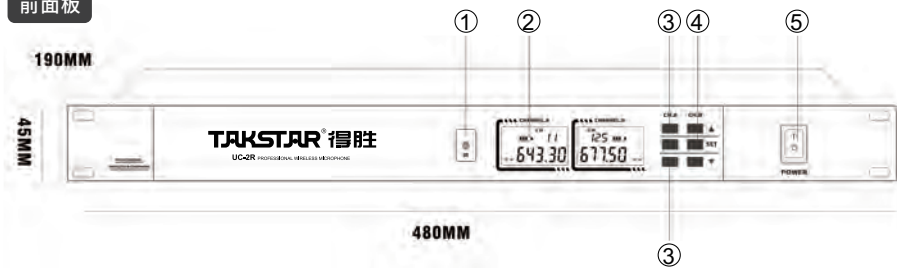

- ① 红外 (IR) 对频窗口：配合“SET”按键，将频率参数传至发射机，使接收机与发射机频率同步。
- ② 液晶显示屏：显示系统当前工作状态。
- ③ 上下按钮（ $\blacktriangle$ ）：用于频率、音量调节等操作。
- ④ 确认按钮 (SET)：按下可选择菜单选项，被选中菜单选项闪烁显示。按下可确认调整当前选中的菜单选项。
- ⑤ 电源开关 (POWER)：用于控制机内电源供应。

#### 后面板

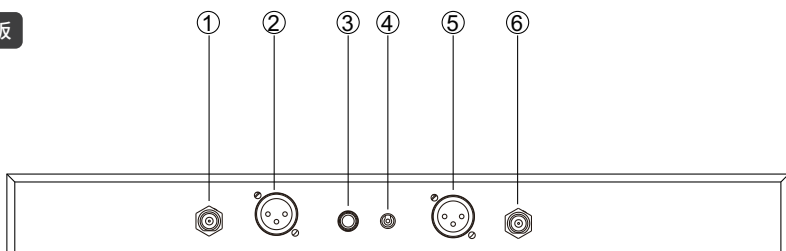

- ① 天线插孔B (ANT-B)：用于连接外置天线。
- ② 平衡输出插座 (BALANCED-B)：采用“XLR”型插座，两通道信号分别输出。
- ③ 6.35mm非平衡混合输出插座 (MIXED OUTPUT)：将两路音频信号混合成一路输出。
- ④ 电源插座 (DC INPUT)：通过电源适配器为接收机供电。
- ⑤ 平衡输出插座 (BALANCED-A)：采用“XLR”型插座，两通道信号分别输出。
- ⑥ 天线插孔A (ANT-A)：用于连接外置天线。

# UC-2R/UC-4R 无线麦克风

## 接收机(一拖四)

### 前面板

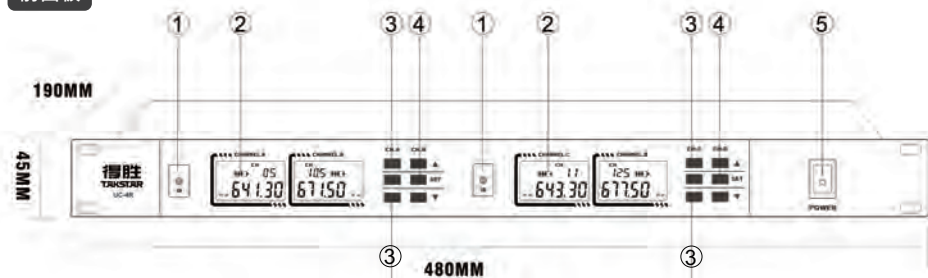

- ① 红外 (IR) 对频窗口：配合“SET”按键，将频率参数传至发射机，使接收机与发射机频率同步。
- ② 液晶显示屏：显示系统当前工作状态。
- ③ 上下按钮（ $\blacktriangle$ ）：用于频率、音量调节等操作。
- ④ 确认按钮 (SET)：按下可选择菜单选项，被选中菜单选项闪动显示。按下可确认调整当前选中的菜单选项。
- ⑤ 电源开关 (POWER)：用于控制机内电源供应。

### 后面板

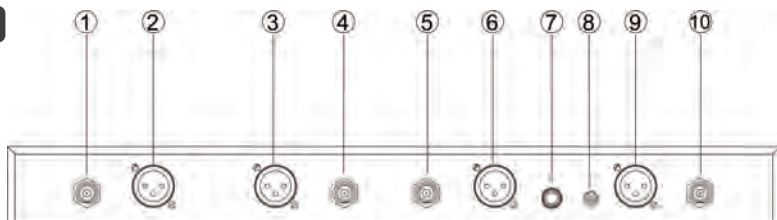

- ① 天线连接座D (ANT-D)：用于连接外置天线。
- ② 平衡输出插座 (BALANCED-D)：采用“XLR”型插座，提供各通道独立信号输出。
- ③ 平衡输出插座 (BALANCED-C)：采用“XLR”型插座，提供各通道独立信号输出。
- ④ 天线连接座C (ANT-C)：用于连接外置天线。
- ⑤ 天线连接座B (ANT-B)：用于连接外置天线。
- ⑥ 平衡输出插座 (BALANCED-B)：采用“XLR”型插座，提供各通道独立信号输出。
- ⑦ 6.35mm非平衡混合输出插座 (MIXED OUTPUT)：将四路音频信号混合成一路输出。
- ⑧ 电源插座 (DC INPUT)：通过电源适配器为接收机供电。
- ⑨ 平衡输出插座 (BALANCED-A)：采用“XLR”型插座，提供各通道独立信号输出。
- ⑩ 天线插孔A (ANT-A)：用于连接外置天线。

# UC-2R/UC-4R 无线麦克风

## UC-TD手持式发射机

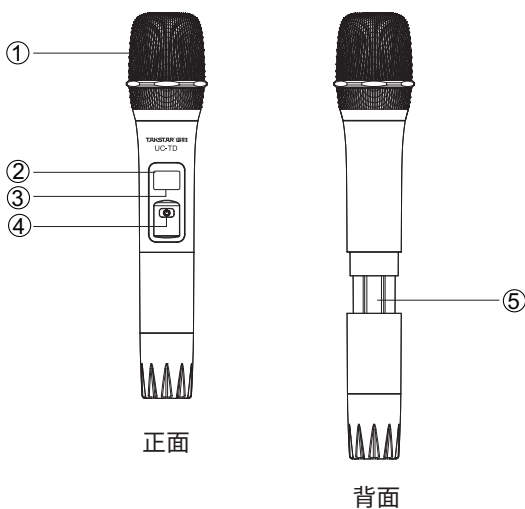

- ① 网头及音头模组：网头用以保护将声音转换成音频信号的音头模组，滤除“POP”气流等杂音干扰，并能防止麦克风放置在桌面时滚动。
- ② LCD液晶显示屏：显示工作频道、电池电量、红外线对频操作等。
- ③ 红外对频窗口：配合接收机“SET”键，将频道参数传至发射器。
- ④ 电源开关：点按开启麦克风电源，长按关闭麦克风电源。
- ⑤ 电池仓：安装2节AA碱性电池。（注意电池放置极性）

# UC-2R/UC-4R 无线麦克风

## UC-LD手持式发射机

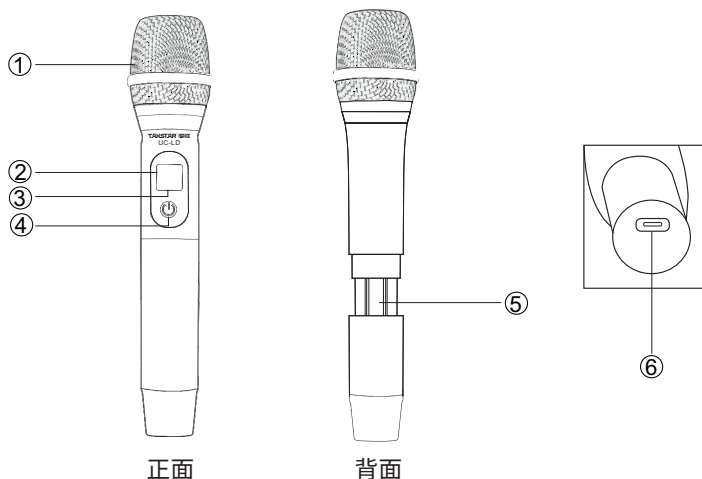

- ① 网头及音头模组：网头用以保护将声音转换成音频信号的音头模组，滤除“POP”气流等杂音干扰，并能防止麦克风放置在桌面时滚动。
- ② LCD液晶显示屏：显示工作频道、电池电量、红外线对频操作等。
- ③ 红外对频窗口：配合接收机“SET”键，将频道参数传至发射器。
- ④ 电源开关：点开开启麦克风电源，长按关闭麦克风电源。
- ⑤ 电池仓：安装1节3.7V 18650电池。（注意电池放置极性）
- ⑥ Type-C接口：使用Type-C充电线连接适配器为麦克风充电。



# UC-2R/UC-4R 无线麦克风

## 腰挂式发射机

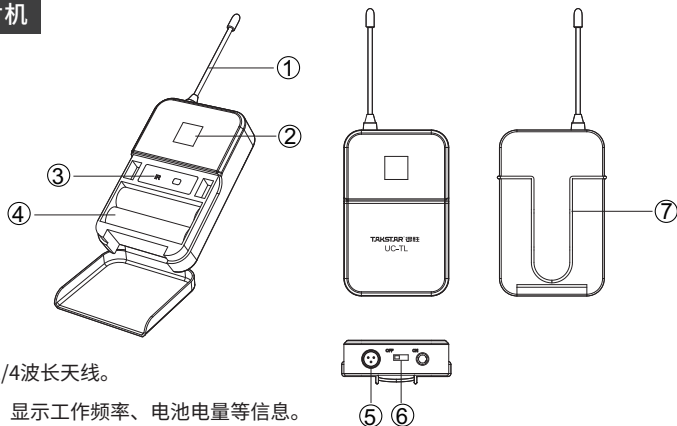

- ① 外置天线：1/4波长天线。
- ② 液晶显示屏：显示工作频率、电池电量等信息。
- ③ 红外对频窗口：接收红外波束，使频率同步。
- ④ 电池仓：用于安装5号电池。（注意电池放置极性）
- ⑤ 3插针话筒输入插座：用于安装及拆卸领夹麦克风或头戴麦克风。
- ⑥ 电源开关：拨至“ON”方向开启电源；拨至“OFF”方向关闭电源。
- ⑦ 腰挂扣：用于将发射器固定于腰带上。

## UC-TH会议发射机

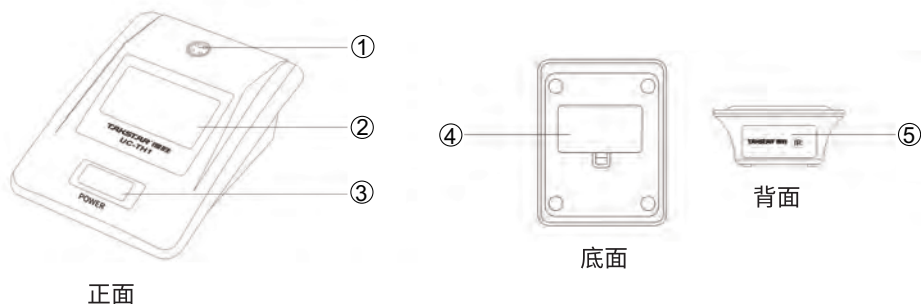

- ① 4插针话筒输入插座：用于安装及拆卸麦克风咪杆。
- ② 液晶显示屏：显示工作频率、电池电量等信息。
- ③ 电源开关：点按开机，开机后点按静音/取消静音，长按关机。
- ④ 电池仓：用于安装5号电池。（注意电池放置极性）
- ⑤ 红外对频窗口：配合接收机“SET”键，将频道参数传至发射器。

# UC-2R/UC-4R 无线麦克风

## UC-LH会议发射机

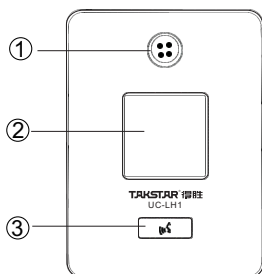

正面

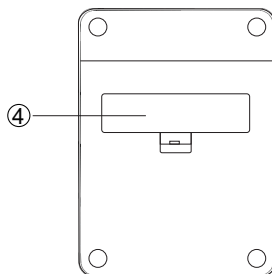

底面

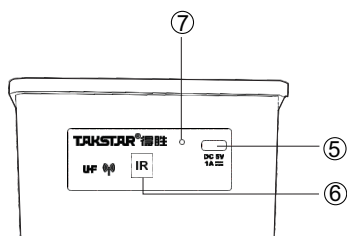

背面

- ① 4插针话筒输入插座：用于安装及拆卸麦克风咪杆。
- ② 液晶显示屏：显示工作频率、电池电量等信息。
- ③ 电源开关：点开开机，开机后点按静音/取消静音，长按关机。
- ④ 电池仓：用于安装1节3.7V 18650电池。（注意电池放置极性）
- ⑤ Type-C接口：使用Type-C充电线连接适配器为麦克风充电。
- ⑥ 红外对频窗口：配合接收机“SET”键，将频道参数传至发射器。
- ⑦ 电源指示灯：充电状态下，指示灯显示红灯，满电状态下显示蓝灯。

# UC-2R/UC-4R 无线麦克风

## ■ 使用说明

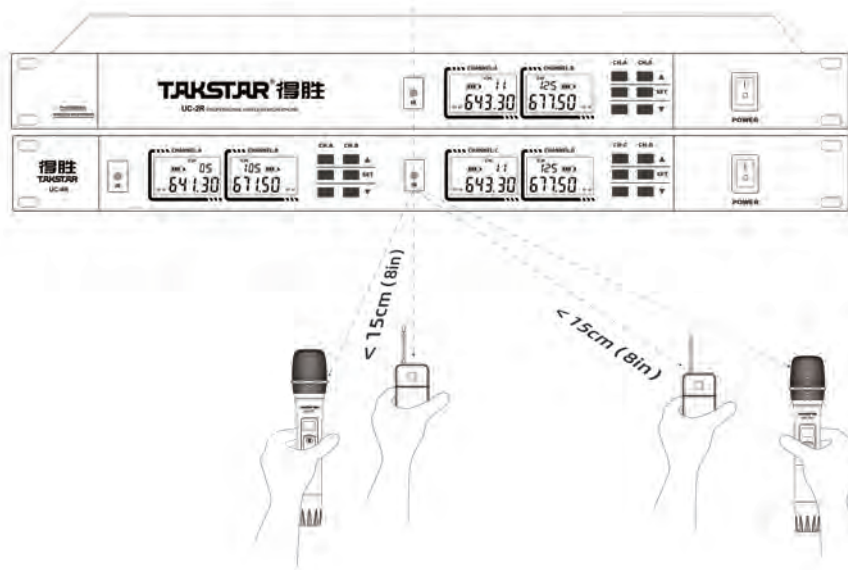

### 1. 手动频率调节:

打开接收机电源开关，在初始界面下，先短按“SET”按键，然后点击对应通道的“▲”键与“▼”键调整到所需频率，当已调整到需要使用的频率时，再点击“SET”按键，显示屏闪烁并出现“IR-”字样表示已进入对频状态，此时打开发射机电源开关，将发射机的红外（IR）窗口与接收机红外（IR）窗口呈直线相对（对频距离可选择在10cm-30cm之间），待发射器显示频率跟接收机的频率一致，且对着麦克风说话有声音时，则表示对频成功；如对频不成功可重新点按“SET”键重复以上操作，直至对频成功。

### 2. 自动扫频操作:

打开接收机电源开关，在初始界面下，先长按“SET”键，然后点击一下对应通道的“▲”或“▼”键，接收机的对应通道会进入自动扫描状态，频率会跳动，当扫描到干净频点时，接收机会自动发出红外对频状态，这时打开发射机电源开关，将发射机上的红外（IR）窗口对准接收机上的红外（IR）窗口即可。

### 3. 系统锁定操作:

打开接收机电源开关，锁定：初始界面下同时长按A、B通道或C、D通道“SET”键2秒，所有功能键将被锁定（电源开关除外）。

解锁：同时长按A、B通道或C、D通道“SET”键2秒，界面可解锁。

# UC-2R/UC-4R 无线麦克风

---

## ■ 安全警示

为避免电击、高温、着火、辐射、爆炸、机械危险以及使用不当等可能造成的人身伤害或财产损失，使用本产品前，请仔细阅读并遵守以下事项：

1. 使用产品时请确认所连接设备与本产品功率是否匹配以及合理调整设备音量大小，不要在超过产品功率及大音量下长时间使用，以免造成产品异常；
2. 使用中若发现有异常（如冒烟、异味等），请立即关闭电源开关并拔掉电源插头，然后将产品送经销商检修；
3. 本产品及配件都应放置在室内干燥通风处，勿长期存放在潮湿、灰尘多的环境，使用中避免靠近火源，雨淋、进水、过度碰撞、抛掷、振动本机及覆盖通风孔，避免损坏其功能；
4. 若产品需要固定于墙壁或天花板上时，请确保固定到位，防止因固定强度不足导致产品发生跌落危险；
5. 使用该产品时需遵守相关安全规定，法律法规明确禁止使用场合请勿使用产品，以免导致意外事故；
6. 请不要自行拆机改装或维修，以防止出现人身伤害，如有问题或服务需求请联系当地经销商跟进处理。
7. 请勿擅自拆卸电池充电，以免PVC受损刮花后导电性能受到影响，进而引发短路、发烫和火灾等安全隐患。
8. 建议您首次使用将锂电池充满电，以确保电池最佳性能。

## ■ 关于本说明书

本说明书中内容符合截止印刷之日的技术规格。由于得胜公司会不断改进产品，本说明书可能不符合您的特定产品的技术规格。要获取最新版说明书，请访问得胜官网，然后下载说明书文件。技术规格、设备或另售的附件在各个地区可能有所不同，如有问题请与当地得胜经销商确认。如需更多支持和深层产品信息，请浏览得胜官方网站：<https://www.takstar.com/>

# UC-2R/UC-4R Wireless Microphone

---

## ■ Preface

Dear Customer,

Thank you for purchasing Takstar UC-2R/UC-4R Wireless Microphone. In order to better understand and use the product, please read this manual carefully. If you have any questions or suggestions, please contact our local dealer.

## ■ Features

- Microcomputer controlled system, featuring frequency selection, LCD display, frequency data processing and automatic channel scan.
- On-board LCD display makes it easier to track system status and modify system settings.
- Transmitter battery level meter on receiver LCD screen, with low-power alert function.
- The system applies a variety of anti-interference technologies, comes with multiple non-interfering frequency presets, convenient for using several systems together.
- XLR balanced outputs and 6.35 unbalanced outputs, for connecting different external devices.
- 1U rack-sized metal chassis, aluminum alloy panel, sturdy, isolating harmonic radiation.

## ■ Applications

For karaoke, performance, conference, program host, speech, outdoor activity

## ■ Specifications

### Receiver (UC-2R/UC-4R)

- Spurious Suppression: N50dB
- Image Rejection: N50dB
- Sensitivity: >25dBu (SIND=35dB)
- Audio Output Level: Balanced output (XLR output jack): 1200mV/600Ω  
Unbalanced output (6.35 output jack) - UC-2R: 900mV/3KΩ  
Unbalanced output (6.35 output jack) - UC-4R: 400mV/3KΩ
- Working Voltage: DC 12V; Working Current: 1A
- Chassis Size: 480 (W) X 190 (D) X 45 (H) mm

# UC-2R/UC-4R Wireless Microphone

---

## Transmitter (UC-TH1/UC-TH2/UC-TL/UC-TP/UC-TD)

- RF Power Output: 30mW max
- Oscillation Mode: PLL (digital frequency synthesizer)
- Transmission Frequency Stability: <30ppm
- Dynamic Range: ≥50dB(A)
- Frequency Response: 80Hz-18KHz
- Max Input SPL: 130dB SPL
- Handheld Mic Capsule: dynamic
- Bodypack/Conference Mic Capsule: condenser
- Power Supply: 2PCS AA alkaline batteries (expected use time is about 8hrs)

## Transmitter (UC-LD/UC-LH1/UC-LH2)

- RF Power Output: 30mW max
- Oscillation Mode: PLL (digital frequency synthesizer)
- Transmission Frequency Stability: <30ppm
- Dynamic Range: ≥50dB(A)
- Frequency Response: 80Hz-18KHz
- Spurious Suppression: -60dB
- Handheld Mic Capsule: dynamic
- Conference Mic Capsule: condenser
- Battery: 1x 18650, 3.7V/1200mA, about 8hrs
- Charging: DC 5V = 1A

## Overall System Parameters

- Frequency Range: 580-630MHz
- Frequency Bandwidth: 60MHz
- Modulation Method: FM
- Max Frequency Deviation: ±45KHz
- Frequency Response: 80Hz-18KHz
- Signal-To-Noise Ratio (S/N): >50dB
- Distortion: 1kHz<0.5%
- Operating Temperature: TOP ~ 55°C
- Working Distance: 100 meters (under ideal conditions)
- Power Consumption: 8W
- Static Power: 3W

Note: The above data is measured by Takstar laboratory.

# UC-2R/UC-4R Wireless Microphone

---

## ■ Package Contents

### UC-2R

Receiver .....	1PCS
Audio Cable .....	1PCS
Power Adapter.....	1PCS
Antenna .....	2PCS
User Manual .....	1PCS

### UC-TP (optional)

Bodypack Transmitter .....	1PCS
Lavalier Mic .....	1PCS
Headset Mic .....	1PCS
1.5V AA Battery .....	2PCS

### UC-TH1 (optional)

Conference Mic Base.....	1PCS
Gooseneck Mic .....	1PCS
1.5V AA Battery .....	2PCS

### UC-LD (optional)

Handheld Transmitter.....	1PCS
3.7V 18650 Battery .....	1PCS
Anti-Slip Ring.....	1PCS
Charging Cable.....	1PCS

### UC-LH2 (optional)

Conference Mic Base.....	1PCS
Short Stem (Rectangular) Mic.....	1PCS
3.7V 18650 Battery .....	1PCS
Charging Cable.....	1PCS

### UC-4R

Receiver .....	1PCS
Audio Cable .....	1PCS
Power Adapter.....	1PCS
Antenna .....	4PCS
User Manual .....	1PCS

### UC-TD (optional)

Handheld Transmitter.....	1PCS
1.5V AA Battery .....	2PCS

### UC-TH2 (optional)

Conference Mic Base.....	1PCS
Short Stem (Rectangular) Mic.....	1PCS
1.5V AA Battery .....	2PCS

### UC-LH1 (optional)

Conference Mic Base.....	1PCS
Gooseneck Mic .....	1PCS
3.7V 18650 Battery .....	1PCS
Charging Cable.....	1PCS

# UC-2R/UC-4R Wireless Microphone

## ■ Function Descriptions

### Receiver (Dual-Channel)

#### Front Panel

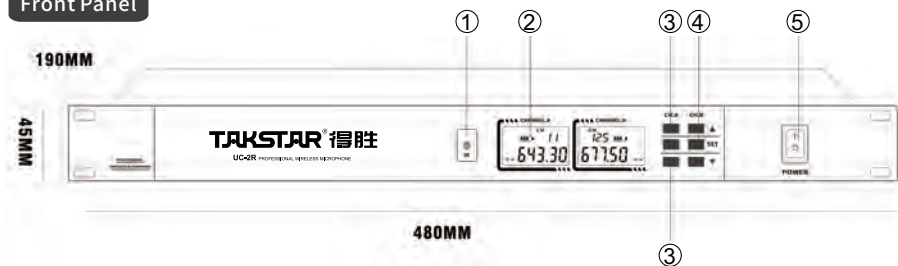

- ① Infrared (IR) Sync Window: transmit frequency parameters to the transmitter to sync transmitter with receiver frequency, by using the “SET” button.
- ② LCD Display: display the system working status.
- ③ Up/Down Buttons (  $\blacktriangle$  /  $\blacktriangledown$  ): used mainly for frequency and volume adjustment.
- ④ Confirmation Button (SET): press it to start or confirm menu selection.
- ⑤ Power Switch (POWER): used for power supply control of the device.

#### Rear Panel

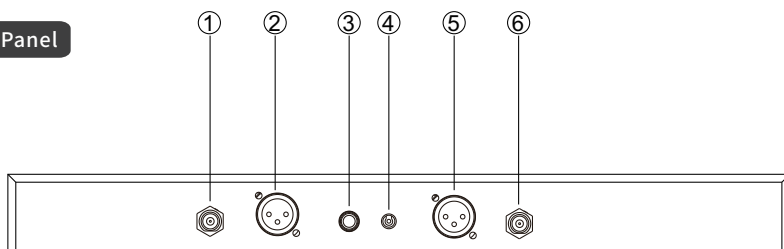

- ① Antenna Connector B (ANT-B): used to connect an external antenna.
- ② Balanced Output Socket (BALANCED-B): XLR connector; signals of the two channels are output separately.
- ③ 6.35mm Unbalanced Mixed Output Socket (MIXED OUTPUT): signals of the two channels are mixed into one output.
- ④ Power Socket (DC INPUT): accept power supply to the receiver via a power adapter.
- ⑤ Balanced Output Socket (BALANCED-A): XLR connector; signals of the two channels are output separately.
- ⑥ Antenna Connector A (ANT-A): used to connect an external antenna.



# UC-2R/UC-4R Wireless Microphone

## Receiver (Four-Channel)

### Front Panel

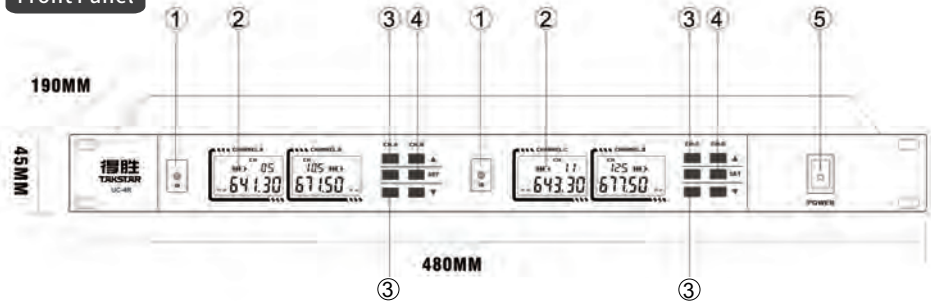

- ① Infrared (IR) Sync Window: transmit frequency parameters to the transmitter to sync transmitter with receiver frequency, by using the “SET” button.
- ② LCD Display: display the system working status.
- ③ Up/Down Buttons (  $\blacktriangle$  /  $\blacktriangledown$  ): used mainly for frequency and volume adjustment.
- ④ Confirmation Button (SET): press it to start or confirm menu selection.
- ⑤ Power Switch (POWER): used for power supply control of the device.

### Rear Panel

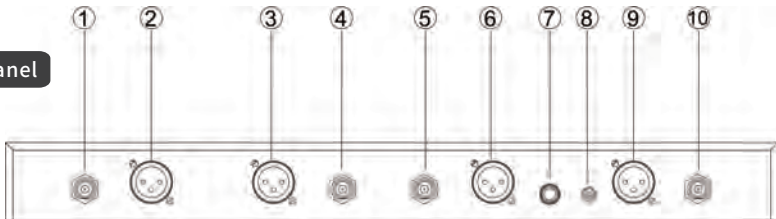

- ① Antenna Connector D (ANT-D): used to connect an external antenna.
- ② Balanced Output Socket (BALANCED-D): XLR connector; signals of each channel are output separately.
- ③ Balanced Output Socket (BALANCED-C): XLR connector; signals of each channel are output separately.
- ④ Antenna Connector C (ANT-C): used to connect an external antenna.
- ⑤ Antenna Connector B (ANT-B): used to connect an external antenna.
- ⑥ Balanced Output Socket (BALANCED-B): XLR connector; signals of each channel are output separately.
- ⑦ 6.35mm Unbalanced Mixed Output Socket (MIXED OUTPUT): signals of all four channels are mixed into one output.
- ⑧ Power Socket (DC INPUT): accept power supply to the receiver via a power adapter.
- ⑨ Balanced Output Socket (BALANCED-A): XLR connector; signals of each channel are output separately.
- ⑩ Antenna Connector A (ANT-A): used to connect an external antenna.

# UC-2R/UC-4R Wireless Microphone

## UC-TD Handheld Transmitter

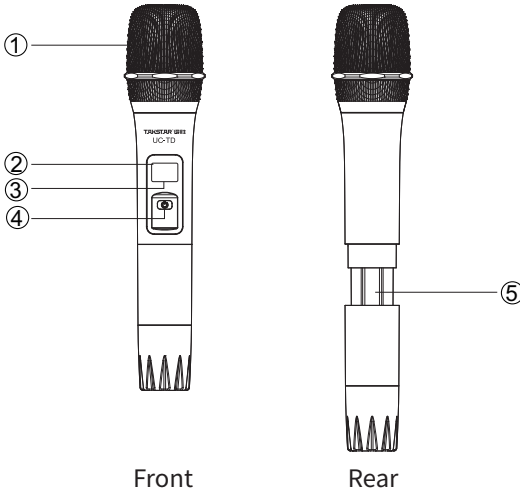

- ① Mesh Head and Capsule Cartridge: the mesh head protects the capsule cartridge (that converts sound to audio signal), filters out pops and airflow noise, and prevents mic from rolling on table.
- ② LCD Display: display the working frequency, battery power, infrared pairing operation, etc.
- ③ Infrared Sync Window: receive frequency parameters from receiver, by using the “SET” button on receiver.
- ④ Power Switch: press to power up the mic, then press and hold to power off.
- ⑤ Battery Compartment: used to install 2PCS AA alkaline batteries. (Please observe battery polarity)

# UC-2R/UC-4R Wireless Microphone

## UC-LD Handheld Transmitter

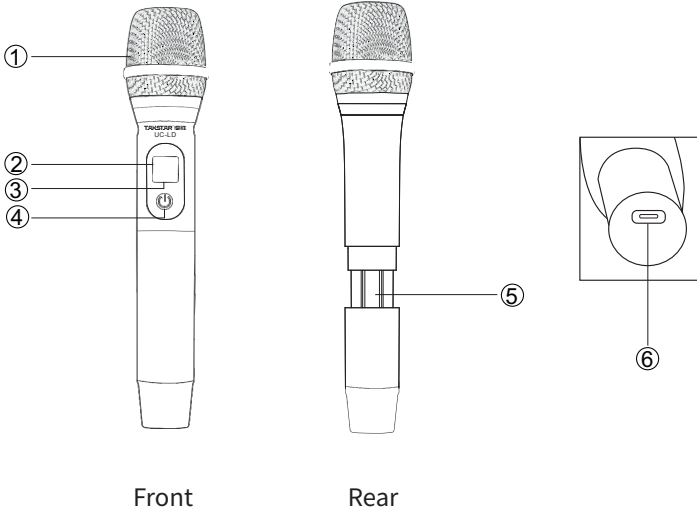

- ① Mesh Head and Capsule Cartridge: the mesh head protects the capsule cartridge (that converts sound to audio signal), filters out pops and airflow noise, and prevents mic from rolling on table.
- ② LCD Display: display the working frequency, battery power, infrared pairing operation, etc.
- ③ Infrared Sync Window: receive frequency parameters from receiver, by using the “SET” button on receiver.
- ④ Power Switch: press to power up the mic, then press and hold to power off.
- ⑤ Battery Compartment: used to install 1x 18650 li-ion battery. (Please observe battery polarity)
- ⑥ Type-C Port: connect a Type-C cable to power adapter for charging the mic.

# UC-2R/UC-4R Wireless Microphone

## Bodypack Transmitter

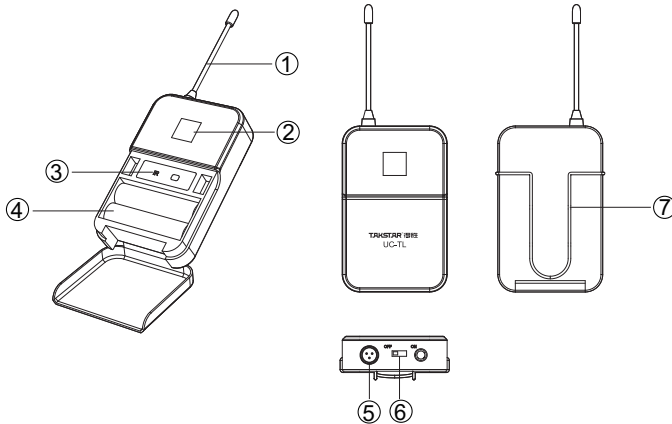

- ① External Antenna: 1/4 wavelength antenna.
- ② LCD Display: display information such as operating frequency and battery power.
- ③ Infrared Sync Window: receive infrared beams to synchronize frequency.
- ④ Battery Compartment: used to install 2PCS AA alkaline batteries. (Please observe battery polarity)
- ⑤ 3-Pin Mic Input Socket: used to install and remove lavalier mic or headset mic.
- ⑥ Power Switch: flip to "ON" direction to power up; flip to "OFF" direction to power off.
- ⑦ Waist Buckle: used to fasten the transmitter onto the belt.

# UC-2R/UC-4R Wireless Microphone

## UC-TH Conference Transmitter

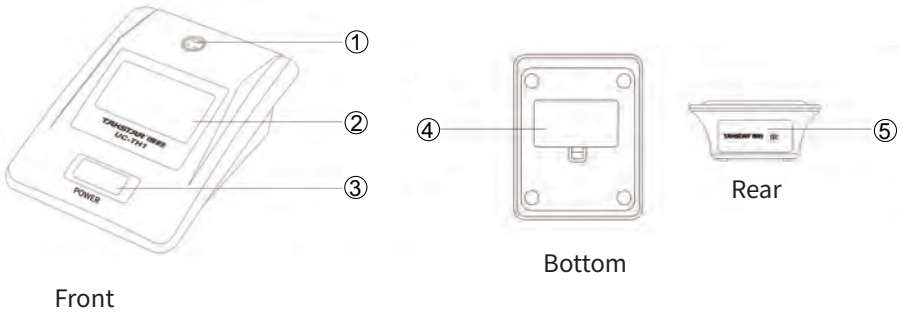

- ① 4-Pin Mic Input Socket: used to install and remove the pluggable mic.
- ② LCD Display: display information such as operating frequency and battery power.
- ③ Power Switch: press to power up, then press to mute/unmute, and press and hold to power off the mic.
- ④ Battery Compartment: used to install 2PCS AA alkaline batteries. (Please observe battery polarity)
- ⑤ Infrared Sync Window: receive frequency parameters from receiver, by using the “SET” button on receiver.

# UC-2R/UC-4R Wireless Microphone

## UC-LH Conference Transmitter

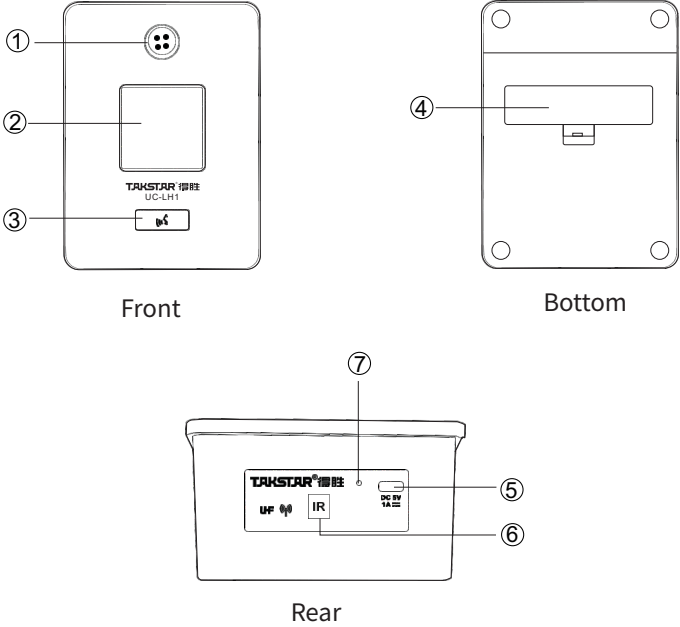

- ① 4-Pin Mic Input Socket: used to install and remove the pluggable mic.
- ② LCD Display: display information such as operating frequency and battery power.
- ③ Power Switch: press to power up, then press to mute/unmute, and press and hold to power off the mic.
- ④ Battery Compartment: used to install 1x 18650 li-ion battery. (Please observe battery polarity)
- ⑤ Type-C Port: connect a Type-C cable to power adapter for charging the mic.
- ⑥ Infrared Sync Window: receive frequency parameters from receiver, by using the “SET” button on receiver.
- ⑦ Power Indicator: shows red when charging and blue when fully charged.

# UC-2R/UC-4R Wireless Microphone

## ■ Operation Instructions

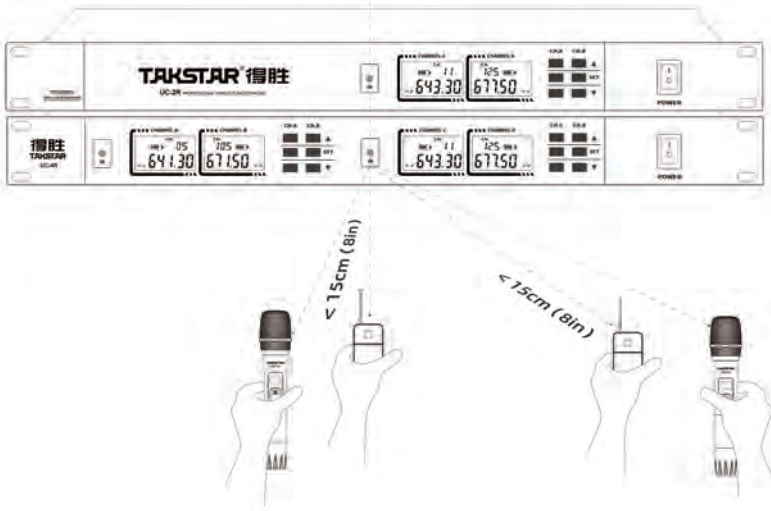

### 1. Manual Frequency Adjustment:

Switch on the receiver power. On default home screen, press "SET" button once, then press "▲" or "▼" button on the respective channel to adjust to a desired frequency. Next, press "SET" again to start pairing, the LCD screen will flicker and show "IR-". Meanwhile, power up the transmitter, align both IR windows on the transmitter and the receiver within 10cm-30cm, and wait until the frequency shown on the transmitter changes to the receiver frequency. If synced successfully, there should be AF audio signal when you talk to the mic. If failed to sync, please retry all the afore steps.

### 2. Automatic Frequency Scan:

Switch on the receiver power. On default home screen, press and hold "SET" button, then press "▲" or "▼" button on the respective channel to start automatic frequency scan. The screen will flicker as it scans. And when it finds the cleanest frequency available, the receiver will begin IR sync automatically. Meanwhile, power up the transmitter, align both IR windows on the transmitter and the receiver to complete syncing.

### 3. System Locking Operation:

**Locking:** In the initial interface, simultaneously press and hold the "SET" button for channels A and B or C and D for 2 seconds, and all function keys will be locked (except for the power switch).

**Unlocking:** To unlock, simultaneously press and hold the "SET" button for channels A and B or C and D for 2 seconds.

# UC-2R/UC-4R Wireless Microphone

---

## ■ Safety Instructions

To avoid electric shock, overheat, fire, radiation, explosion, mechanical risk and injury or property loss due to improper use, please read and observe the following items before use:

1. Please check if the power of the connected equipment matches with that of this product before operation. Adjust the volume to proper level during operation. Do not operate at over-power or high-volume level for extended time to avoid product malfunction or hearing impairment.
2. If there is any abnormality during use (e.g., smoke, strange odor), please kill the power switch and unplug from power source, then send the product to the local dealer for repair.
3. Keep this product and its accessories in a dry and ventilated area. Do not store in a humid or dusty area for extended time. Keep away from fire, rain, liquid intrusion, bumping, throwing, vibrating, or from blocking any ventilation openings, to prevent malfunction.
4. The product must, when installed on walls or ceilings, be fixed firmly in place at adequate strength to prevent from falling.
5. Please abide by safety rules during operation. Do not use the product in places prohibited by laws or regulations to avoid accident.
6. Do not disassemble or repair the product by yourself to avoid injury. If you have any questions or require any services, please contact our local dealer.
7. Do not disassemble the battery charger to avoid damaging the PVC, which can affect conductivity and pose risks of short circuits, overheating, and fire.
8. For optimal performance, please fully charge the lithium-ion battery before its first use.

## ■ About This Manual

This manual contains up-to-date technical specifications as of printing. However, specifications contained herein may not conform to your particular product since Takstar is constantly improving its products. Also, specifications, devices or accessories available may vary from region to region. If you have any questions, please contact our local dealer. For the latest version/more information, please visit our website: <https://www.takstar.com/>



# UC-2R/UC-4R Wireless Microphone

## 产品服务保证书

姓名：\_\_\_\_\_ 电话：\_\_\_\_\_ 地址：\_\_\_\_\_

商品：\_\_\_\_\_ 型号：\_\_\_\_\_ 购买日期：\_\_\_\_\_ 年 \_\_\_ 月 \_\_\_ 日

维修记录栏 (由维修员填写)	维修员签名	日期

### 注意事项：

1. 本单为保修凭证，请用户妥善保管，如有遗失，恕不保修或退换。
2. 保修期限制：购买之日起十二个月内。
3. 除了不可抗力事件损坏外，由本公司负责，免费维修。
4. 如属保管不善或使用不当造成的损坏，维修点将酌情收费。
5. 擅自拆卸维修者，不予保修。
6. 以上保修条款仅限于中国市场适用（不含港澳台地区）。

◆ 广东得胜电子有限公司 ◆ 电话：400-6828-333 ◆ 地址：广东省惠州市博罗县龙溪街道富康一路2号



扫一扫，了解更多产品  
Scan for more  
product information

## **广东省电声工程技术研究中心 广东得胜电子有限公司制造**

地址：广东省惠州市博罗县龙溪街道富康一路2号

服务热线：400 6828 333 传真：0752 6383950

邮箱：xs@takstar.com

网址：www.takstar.com

Guangdong Takstar Electronic Co., Ltd.

Address: No. 2 Fu Kang Yi Rd., Longxi Boluo

Huizhou, Guangdong 516121 China

Tel: 86 752 6383644 Fax: 86 752 6383952

Email: sales@takstar.com

Website: www.takstar.com